

# SPECIFICATIONS

### Operating weight 48,000 kg (105,822 lb)

Operating weight includes coolant, lubricants, full fuel tank, cab, standard shoes, boom, arm, bucket and operator 75 kg (165 lb).

Bucket capacity 2.2-3.2 m<sup>3</sup> (2.88-4.19 yd<sup>3</sup>)

### ENGINE

#### Description

Cummins EPA Tier 4 final / EU Stage IV, 6-cylinder straight Variable-Geometry Turbocharger (VGT), high pressure common rail, electronically controlled direct injection. Air cleaner: Cummins direct flow air filter. Cooling system: Air-to-air intercooler.

Emission rating	EPA Tier 4 final / EU Stage IV
Engine manufacturer	Cummins
Engine model	QSG12
Aspiration	Variable-Geometry Turbocharger (VGT)
Charged air cooling	Aftercooler
Cooling fan drive	Viscous clutch
Displacement	11.8 L (3.12 gal) 11,800 cm <sup>3</sup> (720 in <sup>3</sup> )
Rated speed	2,100 rpm
Engine output - net (SAE J1349 / ISO 9249)	282 kW (378 hp)
Engine output - gross (SAE J1995 / ISO 14396)	298 kW (400 hp)
Maximum torque	2,034 N·m (1,500 lbf·ft) @1,400 rpm
Bore × Stroke	132 × 144 mm (5.2" × 5.7")

### UNDERCARRIAGE

Track shoe each side	51
Link pitch	216 mm (8.5")
Shoe width, triple grouser	600/700/800/900 mm (24"/28"/32"/35")
Bottom rollers each side	9
Top rollers each side	2

### SWING SYSTEM

#### Description

Planetary gear reduction driven by high torque axial piston motor, with oil disk brake. Swing parking brake resets within five seconds after swing pilot controls return to neutral.

Swing speed	8.5 rpm
Swing torque	165,300 N·m (121,919 lbf·ft)

### HYDRAULIC SYSTEM

#### Main pump

Type	Two variable displacement piston pumps
Maximum flow	2 × 380 L/min (2 × 100.4 gal/min)

#### Pilot pump

Type	Gear pump
Maximum flow	28.5 L/min (7.5 gal/min)

#### Relief valve setting

Implement	32.3/35.3 MPa (4,685/ 5,120 psi)
Travel circuit	32.3 MPa (4,685 psi)
Slew circuit	28 MPa (4,061 psi)
Pilot circuit	3.9 MPa (566 psi)

#### Hydraulic cylinders

Boom Cylinder – Bore × Stroke	Φ165 × 1,560 mm (Φ6.5" × 5'1")
Stick Cylinder – Bore × Stroke	Φ190 × 1,980 mm (Φ7.5" × 6'6")
Bucket Cylinder – Bore × Stroke	Φ170 × 1,260 mm (Φ6.7" × 4'2")

### ELECTRIC SYSTEM

System Voltage	24 V
Batteries	2 × 12 V
Alternator	24 V - 70 A
Start motor	24 V - 7.5 kW (24 V - 10.1 hp)

### SERVICE CAPACITIES

Fuel tank	650 L (171.7 gal)
Engine oil	34 L (9.0 gal)
Final drive (each)	15 L (4.0 gal)
Swing drive	2 × 5.3 L (2 × 1.4 gal)
Cooling system	33 L (8.7 gal)
Hydraulic reservoir	290 L (76.6 gal)
Hydraulic system total	520 L (137.4 gal)
DEF tank	56.8 L (15 gal)

### SOUND PERFORMANCE

Interior Sound Power Level (ISO 6396)	76 dB(A)
Exterior Sound Power Level (ISO 6395)	106 dB(A)

### DRIVE AND BRAKES

#### Description

2-speed axial piston motors with oil disk brakes. Steering controlled by two hand levers with pedals.

Max. travel speed	High: 5.5 km/h (3.4 mph) Low: 3.3 km/h (2.1 mph)
Gradeability	35°/70%
Max. drawbar pull	320 kN (71,939 lbf)

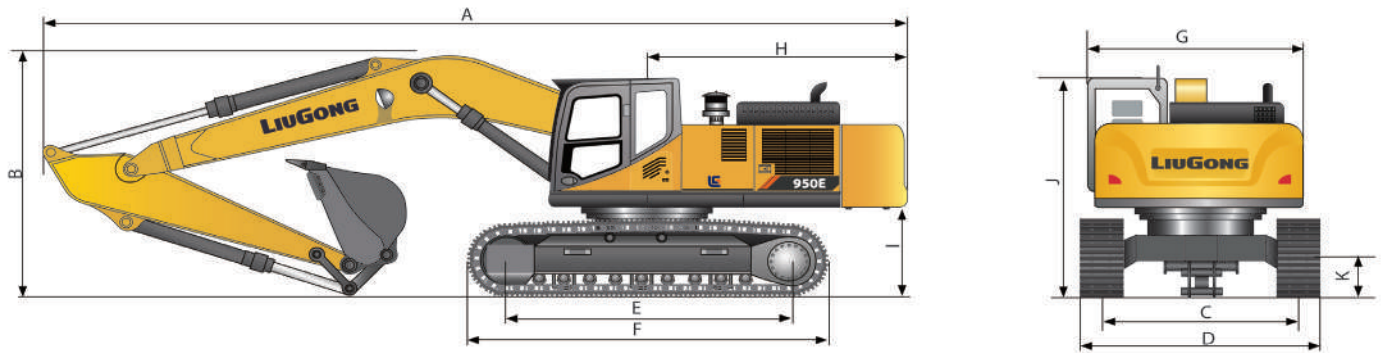

## DIMENSIONS

Boom	6,500 mm (21'4")	7,060 mm (23'2")	
Arm Options	2,550 mm (8'4")	2,900 mm (9'6")	3,380 mm (11'1")
A Shipping Length	11,515 mm (37'9")	12,030 mm (39'6")	12,062 mm (39'7")
B Shipping Height – Top of Boom	3,810 mm (12'6")	3,810 mm (12'6")	3,690 mm (12'1")
C Track Gauge	2,740 mm (9')	2,740 mm (9')	
D Undercarriage Width – 600 mm shoes	3,340 mm (10'11")	3,340 mm (10'11")	
700 mm shoes	3,440 mm (11'3")	3,440 mm (11'3")	
800 mm shoes	3,540 mm (11'7")	3,540 mm (11'7")	
900 mm shoes	3,640 mm (11'11")	3,640 mm (11'11")	
E Length to Center of Rollers	4,257 mm (14')	4,257 mm (14')	
F Track Length	5,256 mm (17'3")	5,256 mm (17'3")	
G Overall Width of Upper Structure	3,170 mm (10'5")	3,170 mm (10'5")	
	(including protective side beam)	(including protective side beam)	
H Tail Swing Radius	3,640 mm (11'11")	3,640 mm (11'11")	
I Counterweight Ground Clearance	1,324 mm (4'4")	1,324 mm (4'4")	
J Overall Height of Cab	3,307 mm (10'11")	3,307 mm (10'11")	
	(with protective equipment)	(with protective equipment)	
K Min. Ground Clearance	532 mm (1'9")	532 mm (1'9")	
L Track Shoe Width	600 mm (24")	600 mm (24")	

## BOOM DIMENSIONS

Description	Standard	Option
Boom	6,500 mm (21'4")	7,060 mm (23'2")
Length	6,800 mm (22'4")	7,350 mm (24'1")
Height	1,910 mm (6'3")	1,850 mm (6'1")
Width	1,057 mm (2'8" with boom hinge pin 3'4")	1,057 mm (3'6")
Weight	4,150 kg (9,149 lb)	4,350 kg (9,590 lb)

Cylinder, piping and pin included. Boom cylinder pin excluded.

## ARM DIMENSIONS

Description	Standard	Short arm	Option
Arm	2,550 mm (8'4")	2,900 mm (9'6")	3,380 mm (11'1")
Length	3,885 mm (12'9")	4,245 mm (13'11")	4,750 mm (15'7")
Height	1,150 mm (3'9")	1,150 mm (3'9")	1,150 mm (3'9")
Width	602 mm (2') with hinge pin	602 mm (2') with hinge pin	602 mm (2') with hinge pin
Weight	2,390 kg (5,269 lb)	2,310 kg (5,093 lb)	2,500 kg (5,512 lb)

Cylinder, linkage and pin included.

## BUCKET SELECTION GUIDE

Bucket type	Capacity	Cutting width	Weight	Teeth PCS	6.4 m (21') HD Boom		7.06 m (21') HD Boom	
					3.2 m (10'6") Arm	2.9 m (9'6") Arm	3.38 m (11'1") Arm	3.38 m (11'1") Arm
Heavy Duty	2.2 m <sup>3</sup> (2.88 yd <sup>3</sup> )	1,775 mm (5'10")	2,092 kg (4,612lb)	5	NA	D	D	D
	2.6 m <sup>3</sup> (3.4 yd <sup>3</sup> )	1,602 mm (5'3")	2,220 kg (4,894 lb)	5	B	B	B	B
	3.2 m <sup>3</sup> (4.19 yd <sup>3</sup> )	1,900 mm (6'3")	2,817 kg (6,210 lb)	6	A	NA	NA	NA

The recommendations are given as a guide only, based on typical operation conditions. Bucket capacity based on ISO 7451, heaped material with a 1:1 angle of repose.

Maximum material density:

- A. 1,200-1,300 kg/m<sup>3</sup> (2,023-2,191 lb/yd<sup>3</sup>): Coal, Caliche, Shale
- B. 1,400-1,600 kg/m<sup>3</sup> (2,360-2,697 lb/yd<sup>3</sup>): Wet earth and clay, limestone, sandstone
- C. 1,700-1,800 kg/m<sup>3</sup> (2,865-3,034 lb/yd<sup>3</sup>): Granite, wet sand, well blasted rock
- D. 1,900 kg/m<sup>3</sup> (3,203 lb/yd<sup>3</sup>): Wet mud, Iron ore
- NA. Not applicable

## MACHINE WEIGHTS AND GROUND PRESSURE

Shoe width	Operating weight	Ground pressure	Overall width	Operating weight	Ground pressure	Overall width
	6.5 m (21'4") boom/2.55 m (8'4") arm/3.2 m <sup>3</sup> (4.19 yd <sup>3</sup> ) bucket/ 9,000 kg (19,842 lb) counterweight			7.06 m (21'4") boom/2.9 m (9'6") arm/2.2 m <sup>3</sup> (2.88 yd <sup>3</sup> ) bucket/ 9,000 kg (19,842 lb) counterweight		
600 mm (24")	48,000 kg (105,822 lb)	84.9 kPa (12.3 psi)	3,340 mm (10' 11")	48,000 kg (105,822 lb)	84.9 kPa (12.3 psi)	3,340 mm (10' 11")
700 mm (28")	48,600 kg (107,145 lb)	73.7 kPa (10.7 psi)	3,440 mm (11' 3")	48,600 kg (107,145 lb)	73.7 kPa (10.7 psi)	3,440 mm (11' 3")
800 mm (32")	49,200 kg (108,467 lb)	65.3 kPa (9.5 psi)	3,540 mm (11' 7")	49,200 kg (108,467 lb)	65.3 kPa (9.5 psi)	3,540 mm (11' 7")
900 mm (35")	49,800 kg (109,790 lb)	58.7 kPa (8.5 psi)	3,640 mm (11' 11")	49,800 kg (109,790 lb)	58.7 kPa (8.5 psi)	3,640 mm (11' 11")

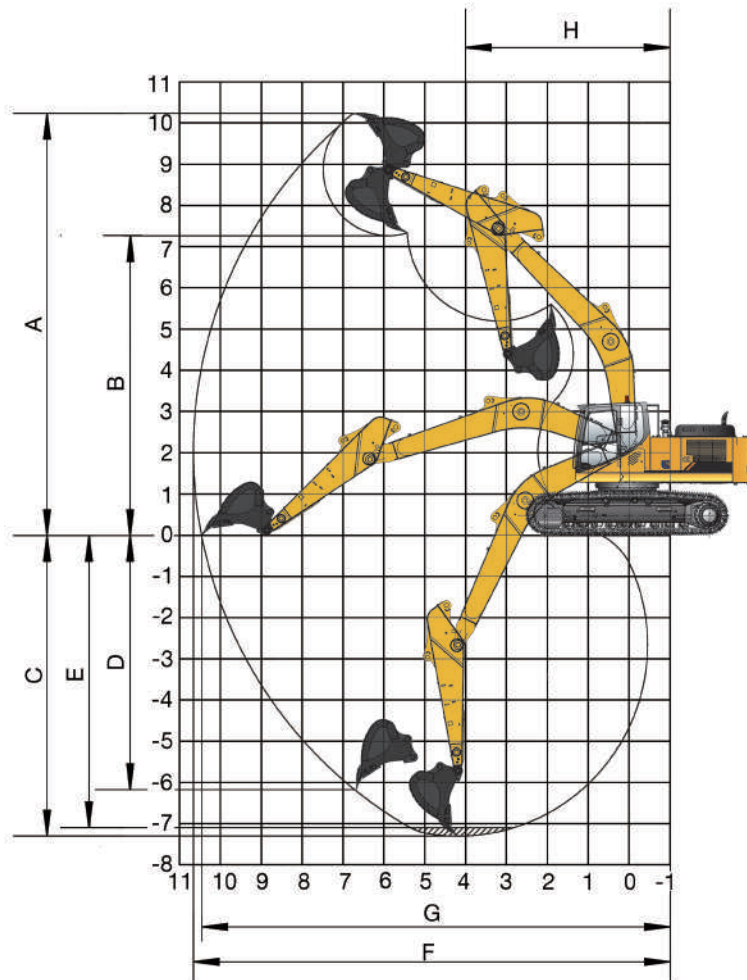

## WORKING RANGE

Boom Length		6,500 mm (21'4")	7,060 mm (23'2")	
Arm Length		2,550 mm (8'4")	2,900 mm (9'6")	3,380 mm (11'1")
A. Max. cutting height		9,977 mm (32'9")	10,618 mm (34'10")	10,785 mm (35'5")
B. Max. dumping height		7,038 mm (23'1")	7,578 mm (24'10")	7,520 mm (24'8")
C. Max. digging depth		6,521 mm (21'5")	7,380 mm (24'3")	7,860 mm (25'9")
D. Max. vertical wall digging depth		5,204 mm (17'1")	6,011 mm (19'9")	6,435 mm (21'1")
E. Max. digging depth 2.44 m (8') level		6,337 mm (20'9")	7,218 mm (23'8")	7,715 mm (25'4")
F. Max. digging reach		10,625 mm (34'10")	11,585 mm (38')	12,020 mm (39'5")
G. Max. digging reach on ground		10,388 mm (34'1")	11,368 mm (37'4")	11,810 mm (38'9")
H. Min. front swing radius		4,645 mm (15'3")	5,052 mm (16'7")	5,015 mm (16'5")
Bucket Digging Force (ISO)	Normal	265 kN (59,574 lbf)	240 kN (53,954 lbf)	209 kN (46,985 lbf)
	Power Boost	280 kN (62,947 lbf)	263 kN (59,125 lbf)	225 kN (50,582 lbf)
Stick Digging Force (ISO)	Normal	255 kN (57,326 lbf)	263 kN (59,125 lbf)	268 kN (60,249 lbf)
	Power Boost	270 kN (60,698 lbf)	287 kN (64,520 lbf)	288 kN (64,745 lbf)
Bucket Capacity		3.2 m <sup>3</sup> (4.19 yd <sup>3</sup> )	2.2 m <sup>3</sup> (2.88 yd <sup>3</sup> )	2.2 m <sup>3</sup> (2.88 yd <sup>3</sup> )
Bucket Tip Radius		1,845 mm (6'1")	1,837 mm (6')	1,837 mm (6')

Lifting capacity at the arm end without bucket.  
For lifting capacity including bucket, weight of the bucket or the bucket with quick coupler must be deducted from the lifting capacities.

Lifting capacities are based on the machine standing on a firm, uniform supporting surface.



Rating over-front (Cf)



Rating over-side (Cs)

1. Do not attempt to lift or hold any load that is greater than these rated values at their specified load radius and height. Weight of all accessories must be deducted from the above lifting capacities.
2. The rated loads are in compliance with ISO 10567 Hydraulic Excavator Lift Capacity Rating Standard. They do not exceed 87% of hydraulic lifting capacity or 75% tipping load.
3. Ratings at bucket lift hook.

4. Lifting capacities are based on machine standing on level, firm and uniform ground.
5. \*Indicates the load is limited by hydraulic capacity rather than tipping capacity.
6. Operator should be fully acquainted with the Operator's and Maintenance Instructions before operating this machine and rules for the safe operation of equipment should be adhered to at all times.

### LIFTING CAPACITY (METRIC)

#### 950E with 600 mm Shoes, 6,500 mm Boom, 2,550 mm Arm

A: Load radius  
B: Load point height  
C: Lifting capacity rating  
Cf: Rating loads over front  
Cs: Rating loads over side

#### Conditions

Boom length: 6,500 mm  
Arm length: 2,550 mm  
Bucket: None  
Counterweight: 9,000 kg  
Shoes: 600 mm triple grouser  
Unit: kg

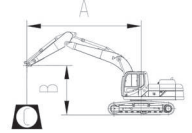

#### A (Unit: m)

B (m)	3		4.5		6		7.5		MAX REACH		A (m)	
	Cf	Cs	Cf	Cs	Cf	Cs	Cf	Cs	Cf	Cs		
7.5										*12,940	11,160	7.1
6					*14,660	14,300	*13,110	10,180	*12,820	9,190		8
4.5			*20,860	20,710	*16,060	13,650	*13,630	9,920	12,440	8,250		8.5
3					*17,550	12,930	*14,310	9,590	11,640	7,690		8.8
1.5					*18,460	12,400	14,400	9,300	11,500	7,570		8.8
GROUND LEVEL			*23,890	18,140	*18,410	12,150	14,220	9,140	11,990	7,840		8.5
- 1.5			*21,770	18,290	*17,280	12,150	*13,620	9,150	*12,390	8,490		8
- 3	*20,940	*20,940	*18,300	*18,300	*14,690	12,380			*11,770	10,040		7.1
- 4.5			*12,390	*12,390					*9,640	*9,640		5.7

#### 950E with 600 mm Shoes, 7,060 mm Boom, 2,900 mm Arm

A: Load radius  
B: Load point height  
C: Lifting capacity rating  
Cf: Rating loads over front  
Cs: Rating loads over side

#### Conditions

Boom length: 7,060 mm  
Arm length: 3,380 mm  
Bucket: None  
Counterweight: 9,000 kg  
Shoes: 600 mm triple grouser  
Unit: kg

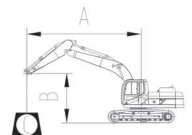

#### A (Unit: m)

B (m)	3		4.5		6		7.5		9		MAX REACH		A (m)
	Cf	Cs	Cf	Cs	Cf	Cs	Cf	Cs	Cf	Cs	Cf	Cs	
7.5							*11,640	10,840			*11,480	9,570	8.1
6							*12,060	10,650	*11,410	7,940	*11,220	8,200	8.9
4.5			*20,560	*20,560	*15,410	14,130	*12,870	10,320	11,700	7,760	11,130	7,440	9.4
3					*17,110	13,410	*13,750	9,950	11,520	7,610	10,490	6,990	9.7
1.5					*18,180	12,890	*14,390	9,640	11,420	7,510	10,390	6,890	9.7
GROUND LEVEL			*19,150	19,010	*18,340	12,640	*14,560	9,460	*11,160	7,530	10,630	7,030	9.5
- 1.5	*22,670	*22,670	*22,140	19,130	*17,580	12,610	*14,060	9,410			*11,160	7,530	9
- 3	*17,480	*17,480	*19,520	19,410	*15,810	12,760	*12,550	9,530			*11,950	8,570	8.2
- 4.5			*15,400	15,400	*12,490	*12,490					*10,080	*10,080	7

Lifting capacity at the arm end without bucket.  
 For lifting capacity including bucket, weight of the bucket or the bucket with quick coupler must be deducted from the lifting capacities.  
 Lifting capacities are based on the machine standing on a firm, uniform supporting surface.



Rating over-front (Cf)



Rating over-side (Cs)

1. Do not attempt to lift or hold any load that is greater than these rated values at their specified load radius and height. Weight of all accessories must be deducted from the above lifting capacities.
2. The rated loads are in compliance with ISO 10567 Hydraulic Excavator Lift Capacity Rating Standard. They do not exceed 87% of hydraulic lifting capacity or 75% tipping load.
3. Ratings at bucket lift hook.
4. Lifting capacities are based on machine standing on level, firm and uniform ground.
5. \*Indicates the load is limited by hydraulic capacity rather than tipping capacity.
6. Operator should be fully acquainted with the Operator's and Maintenance Instructions before operating this machine and rules for the safe operation of equipment should be adhered to at all times.

**LIFTING CAPACITY (IMPERIAL)**

**950E with 24" Shoes, 21' 4" Boom, 8'4" Arm**

A: Load radius  
 B: Load point height  
 C: Lifting capacity rating  
 Cf: Rated loads over front  
 Cs: Rated loads over side

**Conditions**

Boom length: 21'4"  
 Arm length: 8'4"  
 Bucket: None  
 Counterweight: 19,824 lb  
 Shoes: 24" triple grouser  
 Unit: lb

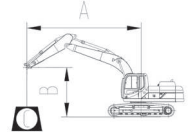

B (ft)	A (Unit: ft)										A (ft)		
	10		15		20		25		MAX REACH				
25											*28,527	24,603	23.3
20								*28,902	22,443	*28,263	20,260		26.2
15			*45,988	45,657	*35,406	30,093	*30,049	21,869	27,425	18,188			27.9
10					*38,691	28,505	*31,548	21,142	25,661	16,953			28.9
5					*40,697	27,337	31,746	20,502	25,353	16,688			28.9
GROUND LEVEL			*52,668	39,991	*40,587	26,786	31,349	20,150	26,433	17,284			27.9
- 5			*47,994	40,322	*38,095	26,786	*30,026	20,172	*27,315	18,717			26.2
- 10	*46,164	*46,164	*40,344	*40,344	*32,385	27,293			*25,948	22,134			23.3
- 15			*27,315	*27,315					*21,252	21,252			18.7

**950E with 24" Shoes, 23'2" Boom, 8'6" Arm**

A: Load radius  
 B: Load point height  
 C: Lifting capacity rating  
 Cf: Rating loads over front  
 Cs: Rating loads over side

**Conditions**

Boom length: 23'2"  
 Arm length: 11'1"  
 Bucket: None  
 Counterweight: 19,824 lb  
 Shoes: 24" triple grouser  
 Unit: lb

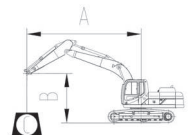

B (ft)	A (Unit: ft)												A (ft)
	10		15		20		25		30		MAX REACH		
	Cf	Cs	Cf	Cs	Cf	Cs	Cf	Cs	Cf	Cs	Cf	Cs	
25											*25,309	21,098	26.6
20							*26,587	23,479	*25,154	17,504	*24,735	18,077	29.2
15			*45,327	*45,327	*33,973	31,151	*28,373	22,751	25,794	17,107	24,537	16,402	30.8
10					*37,721	29,564	*30,313	21,936	25,397	16,777	23,126	15,410	31.8
5					*40,080	28,417	*31,724	21,252	25,176	16,556	22,906	15,189	31.8
GROUND LEVEL			*42,218	41,909	*40,432	27,866	*32,099	20,855	*24,603	16,600	23,435	15,498	31.2
- 5			*48,810	42,174	*38,757	27,800	*30,997	20,745			*24,603	16,600	29.5
- 10	*49,978	*49,978	*43,034	42,791	*34,855	28,130	*27,668	21,010			*26,345	18,893	26.9
- 15	*38,536	*38,536	*33,951	*33,951	*27,535	*27,535					*22,222	*22,222	23.0

Lifting capacity at the arm end without bucket.  
For lifting capacity including bucket, weight of the bucket or the bucket with quick coupler must be deducted from the lifting capacities.  
Lifting capacities are based on the machine standing on a firm, uniform supporting surface.



Rating over-front (Cf)



Rating over-side (Cs)

1. Do not attempt to lift or hold any load that is greater than these rated values at their specified load radius and height. Weight of all accessories must be deducted from the above lifting capacities.
2. The rated loads are in compliance with ISO 10567 Hydraulic Excavator Lift Capacity Rating Standard. They do not exceed 87% of hydraulic lifting capacity or 75% tipping load.
3. Ratings at bucket lift hook.
4. Lifting capacities are based on machine standing on level, firm and uniform ground.
5. \*Indicates the load is limited by hydraulic capacity rather than tipping capacity.
6. Operator should be fully acquainted with the Operator's and Maintenance Instructions before operating this machine and rules for the safe operation of equipment should be adhered to at all times.

**LIFTING CAPACITY (METRIC)**

**950E with 600 mm Shoes, 7,060 mm Boom, 3,380 mm Arm**

A: Load radius  
B: Load point height  
C: Lifting capacity rating  
Cf: Rating loads over front  
Cs: Rating loads over side

**Conditions**

Boom length: 7,060 mm  
Arm length: 2,900 mm  
Bucket: None  
Counterweight: 9,000 kg  
Shoes: 600 mm triple grouser  
Unit: kg

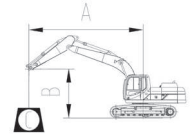

B (m)	A (Unit: m)												A (m)		
	3		4.5		6		7.5		9		MAX REACH				
7.5													*9,030	8,720	8.7
6							*11,840	10,850	*10,980	8,220	*9,610	7,660			9.4
4.5			*19,690	*19,690	*15,110	14,430	*12,740	10,490	*11,340	8,060	*9,490	6,980			9.9
3			*23,590	20,290	*17,000	13,670	*13,750	10,090	11,820	7,860	9,990	6,670			10.1
1.5			*19,220	*19,220	*18,360	13,070	*14,560	9,750	11,610	7,670	9,880	6,570			10.1
GROUND LEVEL			*22,240	19,070	*18,850	12,740	*14,800	9,520	11,470	7,540	10,090	6,680			9.9
- 1.5	*16,380	*16,380	*23,760	19,120	*18,390	12,640	*14,660	9,430	11,440	7,500	10,660	7,040			9.5
- 3	*25,770	*25,770	*21,380	19,340	*16,950	12,730	*13,510	9,480			*10,960	7,930			8.7
- 4.5	*21,360	*21,360	*17,620	*17,620	*14,150	13,000	*10,680	9,760			*10,040	9,610			7.6

**950E with 700 mm Shoes, 7,060 mm Boom, 2,900 mm Arm**

A: Load radius  
B: Load point height  
C: Lifting capacity rating  
Cf: Rating loads over front  
Cs: Rating loads over side

**Conditions**

Boom length: 7,060 mm  
Arm length: 2,900 mm  
Bucket: None  
Counterweight: 9,000 kg  
Shoes: 700 mm triple grouser  
Unit: kg

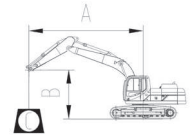

B (m)	A (Unit: m)												A (m)	
	3		4.5		6		7.5		9		MAX REACH			
	Cf	Cs	Cf	Cs	Cf	Cs	Cf	Cs	Cf	Cs	Cf	Cs		
7.5							*11,640	11,030			*11,480	9,750		8.1
6							*12,060	10,840	*11,410	8,090	*11,220	8,350		8.9
4.5			*20,560	*20,560	*15,410	14,380	*12,870	10,510	*11,780	7,920	*11,140	7,580		9.4
3					*17,110	13,660	*13,750	10,140	11,730	7,760	10,680	7,130		9.7
1.5					*18,180	13,140	*14,390	9,830	11,630	7,660	10,580	7,030		9.7
GROUND LEVEL			*19,150	19,010	*18,340	12,890	*14,560	9,650	*11,160	7,680	10,820	7,170		9.5
- 1.5			19,510	19,130	*17,580	12,860	*14,060	9,600			*11,160	7,680		9
- 3	*22,670	*22,670	*19,520	19,410	*15,810	13,010	*12,550	9,720			*11,950	8,740		8.2
- 4.5	*17,480	*17,480	*15,400	*15,400	*12,490	*12,490					*10,080	*10,080		7



Lifting capacity at the arm end without bucket.  
For lifting capacity including bucket, weight of the bucket or the bucket with quick coupler must be deducted from the lifting capacities.

Lifting capacities are based on the machine standing on a firm, uniform supporting surface.



Rating over-front (Cf)



Rating over-side (Cs)

1. Do not attempt to lift or hold any load that is greater than these rated values at their specified load radius and height. Weight of all accessories must be deducted from the above lifting capacities.
2. The rated loads are in compliance with ISO 10567 Hydraulic Excavator Lift Capacity Rating Standard. They do not exceed 87% of hydraulic lifting capacity or 75% tipping load.
3. Ratings at bucket lift hook.
4. Lifting capacities are based on machine standing on level, firm and uniform ground.
5. \*Indicates the load is limited by hydraulic capacity rather than tipping capacity.
6. Operator should be fully acquainted with the Operator's and Maintenance Instructions before operating this machine and rules for the safe operation of equipment should be adhered to at all times.

**LIFTING CAPACITY (IMPERIAL)**

**950E with 24" Shoes, 23'2" Boom, 11'1" Arm**

A: Load radius  
B: Load point height  
C: Lifting capacity rating  
Cf: Rating loads over front  
Cs: Rating loads over side

**Conditions**

Boom length: 23'2"  
Arm length: 9'6"  
Bucket: None  
Counterweight: 19,824 lb  
Shoes: 24" triple grouser  
Unit: lb

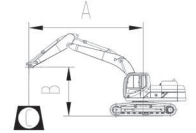

B (ft)	A (Unit: ft)											A (ft)				
	10		15		20		25		30		MAX REACH					
25														*19,907	19,224	28.5
20								*26,102	23,920	*24,206	18,122	*21,186	16,887			30.8
15				*43,409	*43,409	*33,311	31,812	*28,086	23,126	*25,000	17,769	*20,921	15,388			32.5
10				*52,007	44,731	*37,478	30,137	*30,313	22,244	26,058	17,328	22,024	14,704			33.1
5				*42,372	*42,372	*40,476	28,814	*32,099	21,495	25,595	16,909	21,781	14,484			33.1
GROUND LEVEL				*49,030	42,042	*41,557	28,086	*32,628	20,988	25,287	16,622	22,244	14,726			32.5
- 5	*36,111	*36,111	*52,381	42,152	*40,543	27,866	*32,319	20,789	25,220	16,534	23,501	15,520			31.2	
- 10	*56,813	*56,813	*47,134	42,637	*37,368	28,064	*29,784	20,899			*24,162	17,482			28.5	
- 15	*47,090	*47,090	*38,845	*38,845	*31,195	28,660	*23,545	21,517			*22,134	21,186			24.9	

**950E with 28" Shoes, 23'2" Boom, 8'6" Arm**

A: Load radius  
B: Load point height  
C: Lifting capacity rating  
Cf: Rated loads over front  
Cs: Rated loads over side

**Conditions**

Boom length: 23'2"  
Arm length: 9'6"  
Bucket: None  
Counterweight: 19,824 lb  
Shoes: 28" triple grouser  
Unit: lb

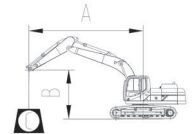

B (ft)	A (Unit: m)												A (ft)				
	10		15		20		25		30		MAX REACH						
	Cf	Cs	Cf	Cs	Cf	Cs	Cf	Cs	Cf	Cs	Cf	Cs	Cf	Cs			
25															*25,309	21,495	26.6
20								*26,587	23,898	*25,154	17,835	*24,735	18,408			29.2	
15				*45,327	*45,327	*33,973	31,702	*28,373	23,170	*25,970	17,460	*24,559	16,711			30.8	
10						*37,721	30,115	*30,313	22,354	25,860	17,107	23,545	15,718			31.8	
5						*40,080	28,968	*31,724	21,671	25,639	16,887	23,324	15,498			31.8	
GROUND LEVEL				*42,218	41,909	*40,432	28,417	*32,099	21,274	*24,603	16,931	23,854	15,807			31.2	
- 5				43,012	42,174	*38,757	28,351	*30,997	21,164			*24,603	16,931			29.5	
- 10	*49,978	*49,978	*43,034	42,791	*34,855	28,682	*27,668	21,428			*26,345	19,268			26.9		
- 15	*38,536	*38,536	*33,951	*33,951	*27,535	27,535					*22,222	22,222			23.0		

Lifting capacity at the arm end without bucket.  
For lifting capacity including bucket, weight of the bucket or the bucket with quick coupler must be deducted from the lifting capacities.  
Lifting capacities are based on the machine standing on a firm, uniform supporting surface.



Rating over-front (Cf)



Rating over-side (Cs)

1. Do not attempt to lift or hold any load that is greater than these rated values at their specified load radius and height. Weight of all accessories must be deducted from the above lifting capacities.
2. The rated loads are in compliance with ISO 10567 Hydraulic Excavator Lift Capacity Rating Standard. They do not exceed 87% of hydraulic lifting capacity or 75% tipping load.
3. Ratings at bucket lift hook.

4. Lifting capacities are based on machine standing on level, firm and uniform ground.
5. \*Indicates the load is limited by hydraulic capacity rather than tipping capacity.
6. Operator should be fully acquainted with the Operator's and Maintenance Instructions before operating this machine and rules for the safe operation of equipment should be adhered to at all times.

### LIFTING CAPACITY (METRIC)

950E with 700 mm Shoes, 7,060 mm Boom, 3,380 mm Arm

#### Conditions

A: Load radius  
B: Load point height  
C: Lifting capacity rating  
Cf: Rated loads over front  
Cs: Rated loads over side

Boom length: 7,060 mm  
Arm length: 3,380 mm  
Bucket: None  
Counterweight: 9,000 kg  
Shoes: 700 mm triple grouser  
Unit: kg

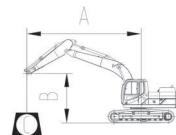

B (m)	A (Unit: m)												A (m)	
	3		4.5		6		7.5		9		MAX REACH			
7.5													8,870	8.7
6													8,230	9.4
4.5			*18,490	*18,490	*14,380	*14,380	*12,220	10,510	*10,960	8,090	*9,490	7,110	9.9	
3			*22,310	20,040	*16,250	13,610	*13,210	10,100	*11,400	7,890	10,170	6,800	10.1	
1.5			*20,900	19,100	*17,530	13,030	*13,960	9,770	11,640	7,700	10,060	6,700	10.1	
GROUND LEVEL			*23,290	18,820	*18,000	12,710	*14,300	9,540	11,510	7,580	10,270	6,820	9.9	
- 1.5	*16,000	*16,000	*22,680	18,850	*17,580	12,600	*14,040	9,450	*11,370	7,550	10,860	7,180	9.5	
- 3	*25,180	*25,180	*20,440	19,060	*16,210	12,690	*12,920	9,510			*10,960	8,080	8.7	
- 4.5	*20,260	*20,260	*16,560	*16,560	*16,211	12,990					*10,040	9,790	7.6	

### LIFTING CAPACITY (IMPERIAL)

950E with 28" mm Shoes, 23'2" Boom, 11'1" Arm

#### Conditions

A: Load radius  
B: Load point height  
C: Lifting capacity rating  
Cf: Rated loads over front  
Cs: Rated loads over side

Boom length: 23'2"  
Arm length: 11'1"  
Bucket: None  
Counterweight: 198,24 lb  
Shoes: 28" triple grouser  
Unit: lb

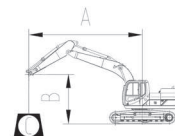

B (ft)	A (Unit: ft)												A (ft)	
	10		15		20		25		30		MAX REACH			
25													19,555	28.5
20													18,144	30.8
15			*40,763	*40,763	*31,702	*31,702	*26,940	23,170	*24,162	17,835	*20,921	15,674	32.5	
10			*49,185	44,180	*35,825	30,004	*29,123	22,266	25,132	17,394	22,421	14,991	33.1	
5			*46,076	42,108	*38,647	28,726	*30,776	21,539	25,661	16,975	22,178	14,770	33.1	
GROUND LEVEL			*51,345	41,491	*39,683	28,020	*31,526	21,032	25,375	16,711	22,641	15,035	32.5	
- 5	*35,273	*35,273	50,000	41,557	*38,757	27,778	*30,952	20,833	*25,066	16,644	23,942	15,829	31.2	
- 10	*55,512	*55,512	*45,062	42,020	*35,736	27,976	*28,483	20,965			*24,162	17,813	28.5	
- 15	*44,665	*44,665	*36,508	*36,508	*35,739	28,638					*22,134	21,583	24.9	



# STANDARD EQUIPMENT

## ENGINE SYSTEM

- Cummins diesel engine, turbocharged, inline 6-cylinder, 4 stroke, water cooled
- Auto-idle speed control
- Air filter with pre-cleaner
- Engine oil filter
- Pre-filter with water separator
- Radiator, oil cooler and intercooler
- IPC (Intelligent Power Control) System
- Engine overheating prevention system

## DRIVETRAIN

- Hydraulic motor, one-piece two-gear piston and reducer
- 2-speed travel system with automatic shift

## SWING SYSTEM

- High-torque piston swing motor with integral spring set and automatic hydraulic release swing brake

## HYDRAULIC SYSTEM

- Main pump: two variable displacement piston pumps, ready for PTO
- Pilot pump: gear
- Cylinders: boom, stick, bucket
- Power boost function
- Boom and arm regeneration circuits
- Pilot oil filter
- Load holding valve
- Pilot control shut-off lever

- Hose burst safety valves, prevention of boom or arm supply dropped when the lines split (2 mounted on boom cylinders, 1 on arm cylinder)
- 6-working mode selection system: Power, Economy, Fine, Lifting, Breaker, Attachment

## DIGGING EQUIPMENT

- 6,500 mm (21'4") boom
- 2,550 mm (8'4") arm
- 3.2 m<sup>3</sup> (4.19 yd<sup>3</sup>) (SAE, heaped) bucket

## OPERATOR STATION

- Pressurized and sealed cab with all-around visibility, large roof window with slide sliding sun visor, front window wiper and removable lower window
- Roll-Over Protective System (ROPS)
- Skylight rooftop
- Air conditioner, heater, defroster
- Swing parking brake
- AM/FM radio with MP3 audio jack
- Glass-breaking hammer
- Ashtray, cigarette lighter
- Cup holder
- Floor mat
- Storage box
- Front glass lower guard
- Fire extinguisher
- Rear view mirrors
- One key for all locks

## INSTRUMENTATION

- Color LCD monitor with alarms, filter/fluid change, fuel rate, water temperature, work mode, fault code, working hour, etc
- Fuel gauge
- Hydraulic oil level gauge

## ELECTRICAL

- Alternator 70 A
- Dual batteries 12 V
- Working lights, 1 frame mounted, 2 boom mounted
- Starting, 24 V

## UNDERCARRIAGE

- 600 mm (24") track-shoes with triple grousers
- 2 piece under-guards (each side)
- Towing eye on base frame

## GUARDS

- Belly guards
- Cover plate under travel frame
- Track shields

## OTHER STANDARD EQUIPMENT

- Counterweight, 9,000 kg (19,842 lb)
- Maintenance tool kit
- Maintenance parts package

# OPTIONAL EQUIPMENT

## ENGINE SYSTEM

- Electrical fuel refilling pump

## HYDRAULIC SYSTEM

- Control pattern change valve
- Hydraulic lines:
  - Breaker & shear
  - Slope & rotator
  - Grapple
  - Oil drain line
  - Quick coupler
- Hydraulic quick coupler
- Overloading valve
- Cushion valve

## OPERATOR STATION

- Power outlet 24 V to 12 V converter
- 4 LED cab top lights
- Working lights on cab (2 on top-front cab)
- Rear view camera 5.7" monitor
- Air suspension seat
- Control joysticks with 2 switch & 1 proportional
- Safety net for front window
- Rain visor
- Travel alarm
- Rotating beacon
- Operation protection guard (included cab front and top guard, bar)
- Operation protection screen (on cab front, net)
- Operation protection screen (front-lower)

## UPPER STRUCTURE

- Upper frame protection (wire)
- Belly guard and 8 mm thickness platform bottom plate
- Bucket cylinder guard

## UNDERCARRIAGE

- 700 mm (28"), 800 mm (32"), 900 mm (35") track-shoes with triple grousers
- 3 piece track-guards (each side)

## DIGGING EQUIPMENT

- 7,060 mm (23'2") boom
- 2,900 mm (9'6") arm
- 3,380 mm (11'1") arm
- 2.2, 2.6 m<sup>3</sup> (2.88, 3.4 yd<sup>3</sup>) (SAE, heaped) bucket



## Guangxi LiuGong Machinery Co., Ltd.

No. 1 Liutai Road, Liuzhou, Guangxi, PR China 545007  
T: +86 772 388 6124 E: overseas@liugong.com  
www.liugong.com

LG-SP-950E-T4F-WW-A4-07072017-ENG

Like and follow us:



The LiuGong series of logos herein, including but not limited to word marks, device marks, letter of alphabet marks and combination marks, as the registered trademarks of Guangxi LiuGong Group Co., Ltd. are used by Guangxi LiuGong Machinery Co., Ltd. with legal permission, and shall not be used without permission. Specifications and designs are subject to change without notice. Illustrations and pictures may include optional equipment and may not include all standard equipment. Equipment and options varies by regional availability.